



Imagen: Puerta corredera lacada - Modelo 100

Sobre nosotros • 4

Historia • 6

Sostenibilidad • 8

Puertas de interior

Serie Lacada • 12

100	14
200	15
300	15
400	15
120	16
420	16
520	16
130	17
440	17
580	18
590	18
610	19
630	21
660	22
670	23
691	23
710	25
722	26
724	26
750	28

810	29
820	30
830	30
840	30
Padua	31

Serie Laminada • 36

Gris Angora	38
Nogal Estocolmo	39
Roble Nature	40
Nogal Arena	41
Vila Gris	42
Fresno Eslovenia	44
Roble Urban	44
Roble Ártico	45
Roble Coffee	45
Roble Finlandés	46
Roble Nórdico	46
Carbón Texture	47
Roble Gold	49

Serie Madera • 52

Malta C6	55
Malta L	56
Malta H	56
Padua	57

120	58
400	58
420	59
520	59

Serie Impress • 62

Blanco Wass	64
Alba Clarium	64
Roble Oxford	65
Quercus Rubra	65
Sapelly	66
Haya Vaporizada	66

Puertas de entrada

Acorazadas	72
Blindada	74
Estándar	74

Molduras y accesorios

Batientes	78
Tapetas	79
Rodapié	80
Kit Corredera	82
Accesorios	83

Guía rápida • 84

Sobre nosotros

Nuestra razón de ser se encuentra en la madera y en la forma en que la tratamos. Nos relacionamos con ella para conservar su fuerza y personalidad a la vez que trabajamos en su funcionalidad. Abrimos las puertas a nuevas sensaciones y entornos, formando parte de la vida de millones de hogares.



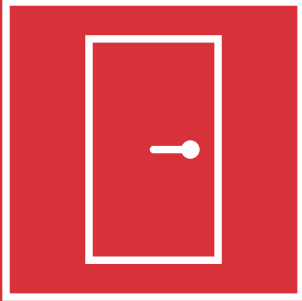

Puertas de interior

Desde la calidez de la serie madera al minimalismo de la serie lacada, las puertas de interior Dimoldura son la solución perfecta para el hogar.

Nuestra amplitud de gama, acabados y un cuidado extremo por los detalles hacen de Dimoldura la opción perfecta para crear espacios únicos y con personalidad.



Serie Madera • 52



Serie Laminada • 36



Serie Impress • 62





Serie Lacada • 12

Elegantes y versátiles a la hora de dar vida a los espacios más preciados, las puertas lacadas aportan una gran sensación de amplitud y luminosidad. Desde puertas lisas a modelos con ranuras, las soluciones son casi infinitas. Todas ellas conforman un sinfín de posibilidades entre las que elegir las más adecuadas para cada estilo. En Dimoldura ofrecemos un gran abanico de modelos y varios acabados como el Confort o el Lacado Premium.



Imagen: Modelo lacado 710 con inserción PVC en Carbón Texture

100

Protect +

Tipos de vidrieras

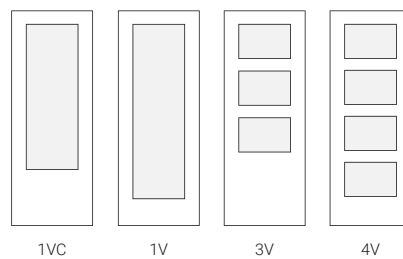

Detalles

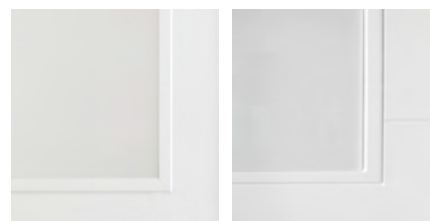

Enrasada



200



300



400

Tipos de vidrieras

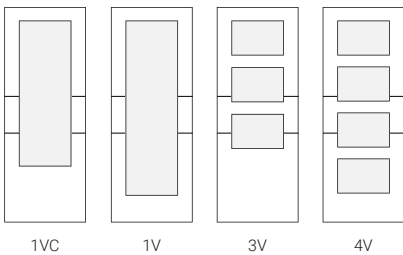

Tipos de vidrieras

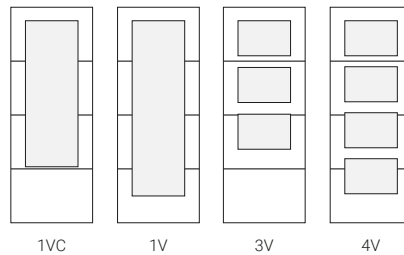

Tipos de vidrieras

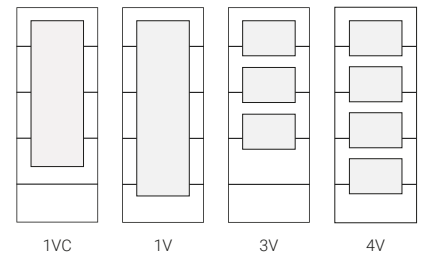

Serie Lacada



120



420



520

Tipos de vidrieras

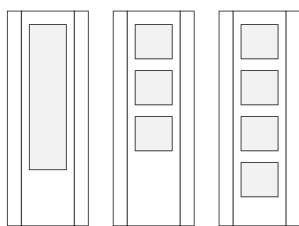

1VCE

3VE

4VE

Tipos de vidrieras

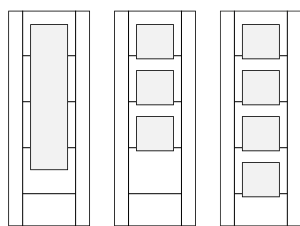

1VCE

3VE

4VE

Tipos de vidrieras

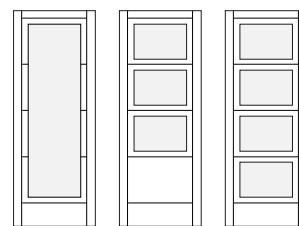

1VCE

3VE

4VE



130

Tipos de vidrieras

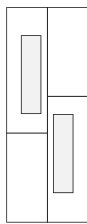

2V



440

Tipos de vidrieras

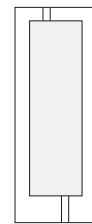

1V



580



590

Tipos de vidrieras

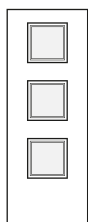

3V



Enrasada

Tipos de vidrieras

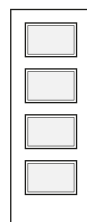

4V



Enrasada



610

Tipos de vidrieras

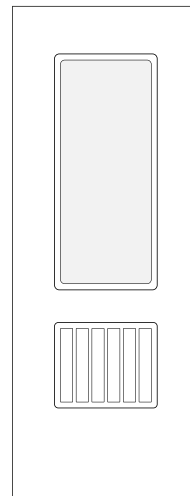

1V

Detalles



Enrasada

Serie Lacada



Imagen: Modelo 630 & 630 TV



630

Tipos de vidrieras

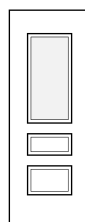

1V



Enrasada

660

Novedad

Tipos de vidrieras

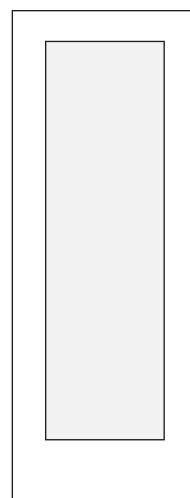

1V

Detalles



Enrasada



670



691

Tipos de vidrieras



Tipos de vidrieras



Serie Lacada



Imagen: Modelo 710 - Inserción PVC en Roble Gold



710

Tipos de vidrieras

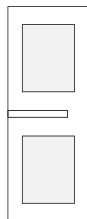

2V

Inserciones PVC disponibles



Nogal Arena



Gris Angora

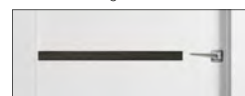

Carbón Texture



Roble Gold

Serie Lacada



722



724

Tipos de vidrieras

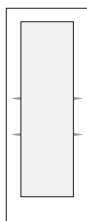

1V



Enrasada

Tipos de vidrieras

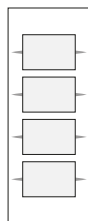

4V



Enrasada





Puertas con protección frente a bacterias

Disponible en los modelos 100, 400 y 724

Las puertas Protect+, disponibles en varios modelos de puertas lacadas y laminadas, previenen el desarrollo y crecimiento de bacterias en general y especialmente de superbacterias como el MRSA y E-Coli en un 99,9%.

Gracias a la **tecnología IonGuard** presente en su superficie, las puertas lacadas Protect+ evitan su proliferación y aseguran un efecto antibacteriano eficaz y duradero.

Su recubrimiento especial libera iones de plata, inhibiendo el crecimiento bacteriano y evitando así que estos microorganismos se multipliquen y reduciendo su presencia hasta en un 99,9%. Cuando las bacterias entran en contacto con una superficie tratada con IonGuard, los iones de plata les impiden seguir desarrollándose y mueren.

Las puertas Protect+ están avaladas por certificaciones y normas científicas internacionales. Además, mantienen inalteradas la belleza y las características técnicas de las puertas Dimoldura, resultando perfectas para espacios de interior.



750

Tipos de vidrieras

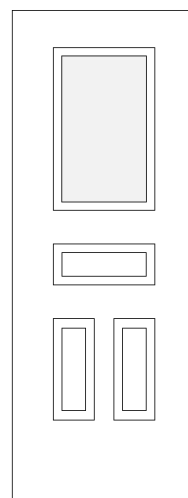

1V

Detalles



Enrasada



810

Novedad

Tipos de vidrieras

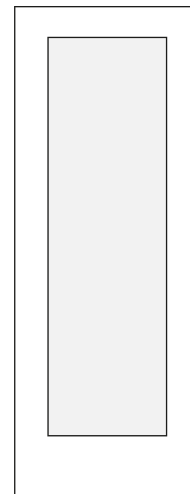

1V

Detalles



Enrasada

Serie Lacada



820

Tipos de vidrieras

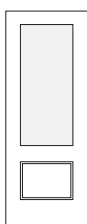

1V



Enrasada



830

Tipos de vidrieras

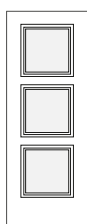

3V



Enrasada



840

Tipos de vidrieras

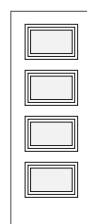

4V



Enrasada

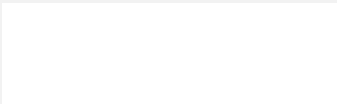

Padua

Tipos de vidrieras

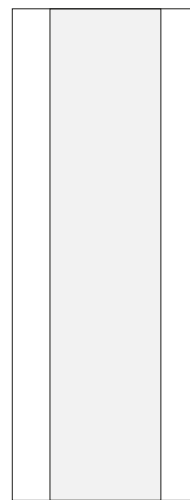

200



Serie Lacada : Características técnicas

Composiciones

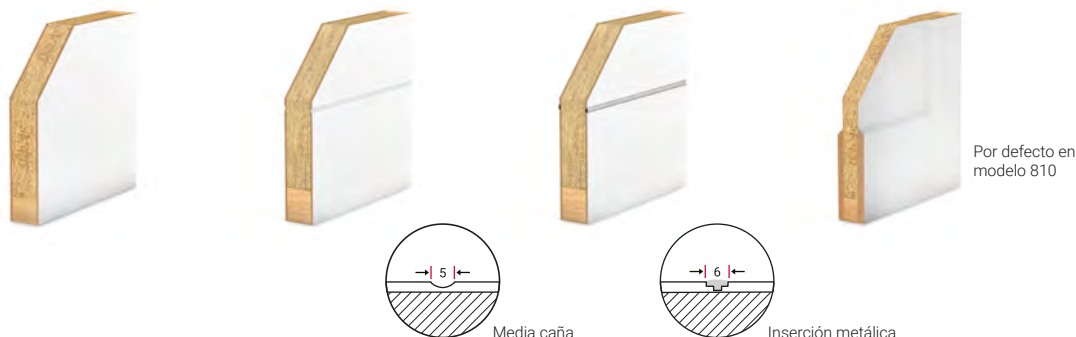

Lisas / fresadas

- Bastidor perimetral de madera de pino o MDF
- Interior aglomerado de baja densidad (500kg/m³)
- Paramentos exteriores MDF 3/4mm de espesor
- Canteado 2 largos



Pantografiadas

- Bastidor perimetral de madera de pino o MDF
- Interior espuma de poliestireno (EPS)
- Paramentos exteriores HDF 7mm de espesor

Montajes vidrieras



Complementos y molduras a juego *



Tapeta acanalada

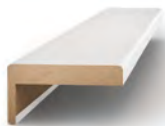

Tapeta extensible



Batiente con burlete



Junquillo de vidrio parrilla

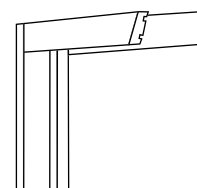

Kit corredera interior



Tapetas / batientes extensibles





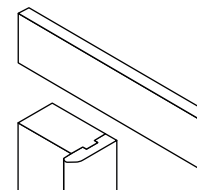

Cercos universales extensibles

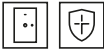

Kit corredera exterior

Medidas estándar (mm) **

Tipo	Alto	Ancho	Grosor
Interior 	2000/2030/2110	605	35
		625	
		705	
		725	
		805	
		825	
Entrada y blindada 	2030	805	45
		925	
Fija 	2000/2030/2110	405	35
		425	
Tablero 	2050/2130	840	5/7
		940	
Resistente al fuego 		Consultar	
Gran formato 		Consultar	

* Consultar para otros modelos

** Consultar para otras medidas

Gama Gran Formato



Imagen: Puerta lacada gran formato / Modelo 200



Las puertas de gran formato son una tendencia en la arquitectura moderna. Su presencia firme y decidida enriquece los espacios interiores otorgándoles una personalidad única y haciendo de ellos estancias singulares con una marcada identidad propia. Sinónimo de elegancia y distinción ofrecen, además, un gran área de paso y una profundidad visual propia de los grandes formatos.

Composición interior

- Paramentos exteriores de 6 mm de grosor
- Interior espuma de poliestireno
- Bastidor perimetral de pino con zapatas inferiores
- Tensores (opción sin tensores disponible)
- Acabado liso (consultar disponibilidad fresado)

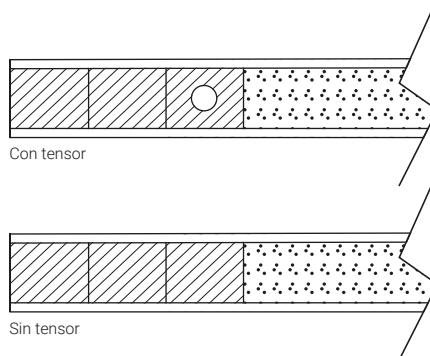

Medidas disponibles preparadas para cortar

- Altura: 2300 / 2500 / 2700 mm
- Anchura: 625* / 725* / 825* / 925* / 1100 / 1200 / 1300 / 1400 / 1500 / 1600 mm (Consultar para otras medidas)
- Grosor: 40 mm

* Disponible para cortar de alto.

Acabados

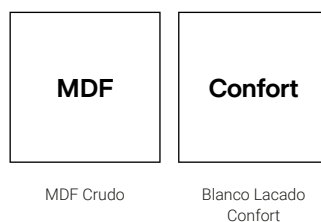



Serie Laminada • 36

La serie de puertas laminadas incorpora los últimos avances en funcionalidad y decoración de espacios interiores, ofreciendo innovadores diseños con acabados laminados texturizados en poro natural.

Propuestas actuales que generan sensaciones cálidas y agradables, como el tacto y la apariencia visual de los acabados en madera. Ideales para todo tipo de ambientes, se presentan en una amplia variedad de acabados, modelos y opciones.

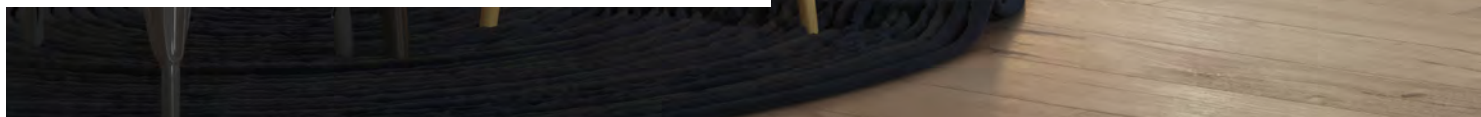





Gris Angora

Veta vertical



Tipos de ranuras





Novedad

Nogal Estocolmo

Veta vertical



Tipos de ranuras



200

300

400

500



Roble Nature

Veta vertical



Tipos de ranuras





Nogal Arena

Novedad

Veta vertical



Tipos de ranuras





Vila Gris

Veta vertical



Tipos de ranuras





Imagen: Modelo Vila Gris con 2 ranuras negras

Serie Laminada



Fresno Eslovenia



Roble Urban

Tipos de ranuras



200

300

400

500

Tipos de ranuras



200

300

400

500



Roble Ártico

Tipos de ranuras



200

300

400

500



Roble Coffee

Tipos de ranuras



200

300

400

500

Serie Laminada



Roble Finlandés



Roble Nórdico

Tipos de ranuras



200 300 400 500

Tipos de ranuras



200 300 400 500

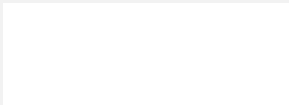

Carbón Texture

Tipos de ranuras



200

300

400

500



Serie Laminada



Imagen: Modelo Roble Gold con 4 ranuras negras -- Ciega / 3V / Corredera



Roble Gold

Tipos de ranuras



200

300

400

500

Serie Laminada : Características técnicas

Composiciones



- Puerta de aglomerado maciza de 35mm
- Tablero de 650kg/m³ de 35mm laminado en ambas caras
- Diseño decorativo con impregnación especial y acabado con poro natural
- Canteado a 4 lados

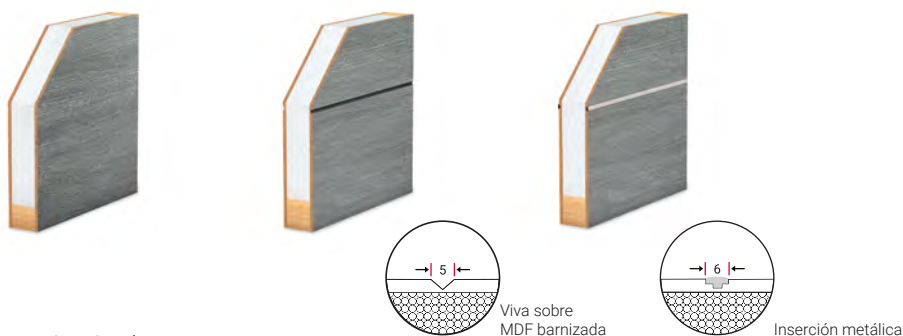

- Puerta interior de porex
- Tableros MDF de 4-5mm
- Bastidor perimetral en pino o MDF
- Canteado a 4 lados

* Consultar diseños disponibles

Montajes vidrieras



Moldura

Tipos de vidrieras

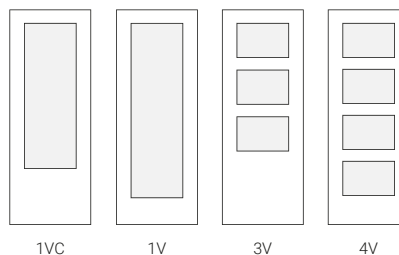

1VC

1V

3V

4V

Complementos y molduras a juego *



Tapeta acanalada



Tapeta extensible



Batiente con burlete



Junquillo de vidrio parrilla

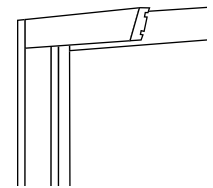

Kit corredera interior



Tapetas / batientes extensibles



Cerco universal extensible

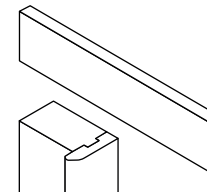

Kit corredera exterior

Medidas estándar (mm) **

Tipo		Alto	Ancho	Grosor
Interior		2030/2110	605	35
			625	
			705	
			725	
			805	
			825	
			925	
Entrada y blindadas		2030/2110	925	45
Fijas		2030/2110	405	35
			425	
Tableros		2050/2130	840	5
			940	
Resistentes al fuego		Consultar		

* Consultar para otros modelos

** Consultar para otras medidas



Serie Madera • 52

Elegancia, versatilidad, durabilidad. Las puertas en madera brindan grandes ventajas. Desde su indiscutible belleza a su calidez o la facilidad para adaptarse a todo tipo de ambientes, sus prestaciones técnicas y estéticas las convierten en una opción inmejorable para el hogar.

Además, en Dimoldura contribuimos al desarrollo sostenible en la obtención de nuestras materias primas como demuestran nuestras certificaciones internacionales.





Imagen: Modelo 520 en Roble

Serie Madera

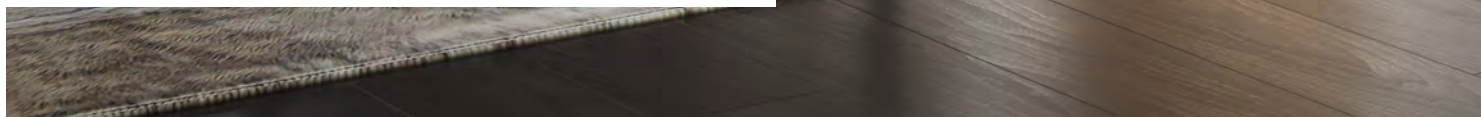

Imagen: Modelo Malta C6 en Nogal



Malta C6

Sapelly

Tipos de vidrieras

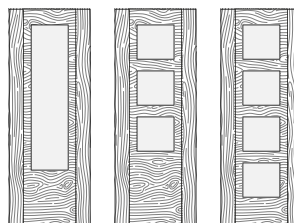

1VCE

3VE

4VE

Serie Madera



Malta L
Roble

Tipos de vidrieras

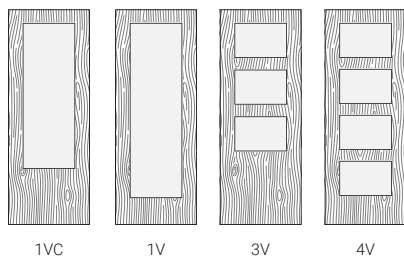

Malta H
Nogal

Tipos de vidrieras

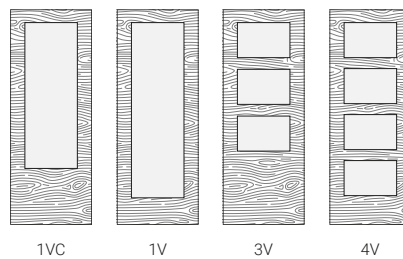



Padua

Roble

Tipos de vidrieras

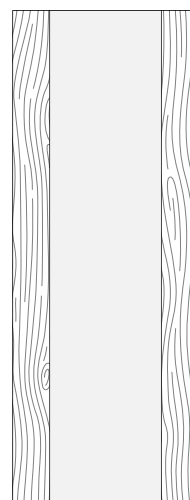

200

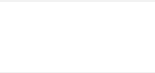

Serie Madera



120
Haya Vaporizada

Tipos de vidrieras

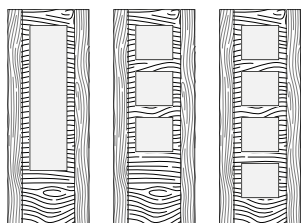

1VCE

3VE

4VE



400
Cerezo

Tipos de vidrieras

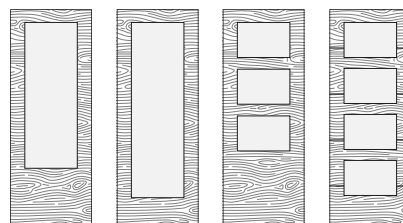

1VC

1V

3V

4V

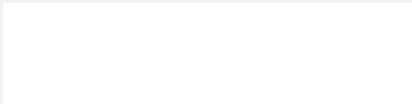

420
Cedro

Tipos de vidrieras

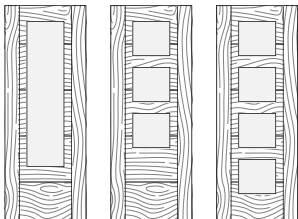

1VCE

3VE

4VE



520
Roble

Tipos de vidrieras

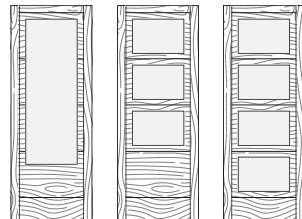

1VCE

3VE

4VE



Serie Madera : Características técnicas

Composiciones

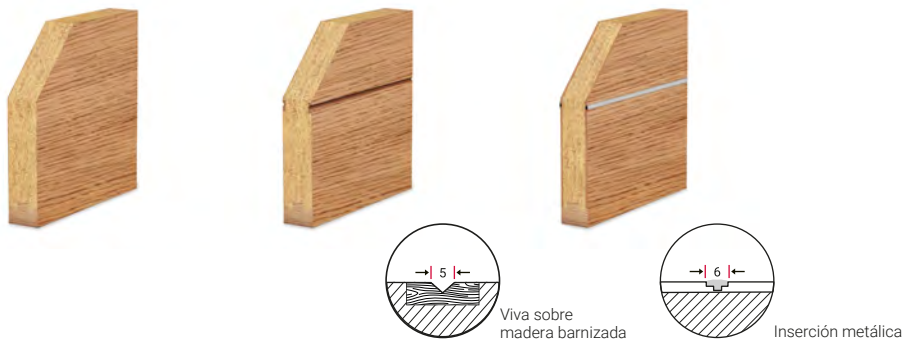

- Recercado perimetral de madera noble
- Interior aglomerado estándar (600-650kg/m³)
- Chapa de madera natural de primera calidad barnizada

Montajes vidrieras

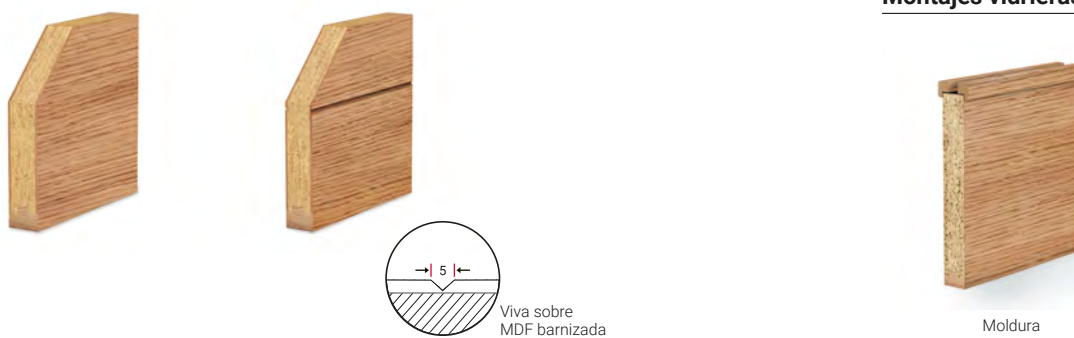

- Recercado perimetral de madera noble
- Interior aglomerado estándar (600-650kg/m³)
- Tableros MDF de 5mm
- Chapa de madera natural

Complementos y molduras a juego *



Tapeta acanalada



Tapeta extensible



Batiente con burlete



Junquillo de vidrio parrilla

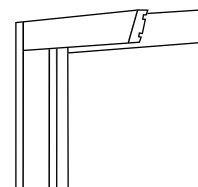

Kit corredera interior



Tapetas / batientes extensibles



Cercos universal extensible

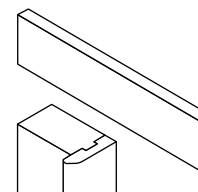

Kit corredera exterior

Acabados



Roble Americano



Roble Europeo



Cedro



Haya Vaporizada

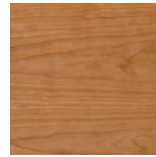

Cerezo

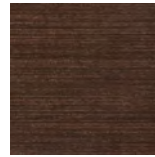

Wengué

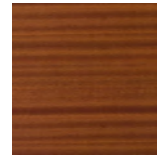

Sapelly



Nogal



Pino Melis

Medidas estándar (mm) **

Tipo		Alto	Ancho	Grosor
Interior		2030/2110	605	35
			625	
			705	
			725	
			805	
			825	
			925	
Entrada y blindadas		2030/2110	805	45
			925	
Fijas		2030/2110	405	35
			425	
Tableros		2050/2130	840	6
			940	
Resistentes al fuego		Consultar		

* Consultar para otros modelos

** Consultar para otras medidas



Serie Impress • 62

La serie Impress tiene como base la innovación tecnológica para conseguir resultados visualmente muy atractivos. Fabricada en impresión mecánica cuenta con varios modelos y acabados.

Con esta nueva incorporación Dimoldura completa una potente oferta en puertas cubriendo todos los segmentos posibles.





Imagen: Modelo Roble Oxford



Blanco Wass

Detalle vidriera



Alba Clarium

Detalle vidriera





Roble Oxford

Detalle vidriera



Quercus Rubra

Detalle vidriera



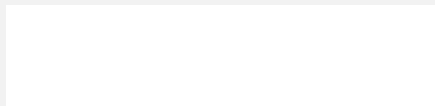

Sapelly

Detalle vidriera



Haya Vaporizada

Detalle vidriera



Serie Impress : Características técnicas

Composiciones



- Bastidor perimetral de MDF o pino
- Interior alveolar
- Paramentos exteriores de MDF de 3mm de espesor
- Canteado 2 largos *

Montajes vidrieras



Moldura

Complementos y molduras a juego *



Tapeta acanalada



Tapeta extensible



Batiente con burlete



Junquillo de vidrio parrilla

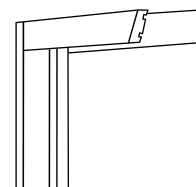

Kit corredera interior



Tapetas / batientes extensibles





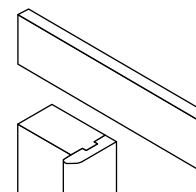

Cerco universal extensible



Kit corredera exterior

Medidas estándar (mm) **

Tipo		Alto	Ancho	Grosor
Interior		2030	625	35
			725	
			825	
			925	
Entrada y blindadas	 	2030	825	45
			925	
Fijas		2030	425	35
Tableros		2050	825	3

* Consultar para otros modelos

** Consultar para otras medidas

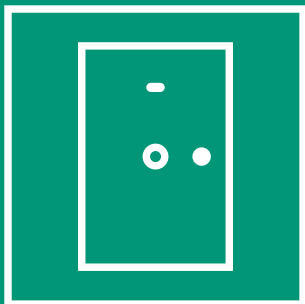

Puertas de entrada

Seguridad y diseño se aúnan para crear una amplia gama de puertas de seguridad Dimoldura. Resistentes y elegantes aseguran la protección máxima.

Con diferentes niveles de seguridad Dimoldura ha desarrollado una completa gama para elevar al máximo el nivel de protección en el hogar.

Porque la primera imagen de una casa la da siempre la puerta de entrada contamos con un gran abanico de posibilidades estéticas.





Imagen: Acorazada panelada en laminado Roble Coffee y armazón plateado

Puertas de entrada



Acorazadas

Garantizar el máximo nivel de seguridad en el hogar es una de las preocupaciones principales a la hora de elegir una puerta de entrada.

La nueva línea de puertas de entrada Di tiene como máximo exponente las puertas acorazadas. La tranquilidad y la seguridad en el acceso al hogar, o cualquier estancia de la casa que se desee proteger especialmente, tienen en las puertas acorazadas el mejor aliado. Su estructura interna de acero galvanizado garantiza una protección extrema ante cualquier intento indeseado de acceso.

Las puertas acorazadas Di han soportado los controles más estrictos de resistencia a la efracción, obteniendo clasificación nivel III, en carga estática (UNE-ENV 1628), en carga dinámica (UNE-ENV 1629) y efracción manual (UNE-ENV 1630). Además, para una mayor seguridad, su estructura incluye un mecanismo de cierre de 3 puntos con 8 bulones y 6 puntos anti-palanca en el lado bisagra.

Las puertas acorazadas Di se pueden fabricar en cualquiera de los modelos disponibles en la gama de puertas de interior, combinando distintas gamas, color de armazón y herrajes.

Acabados



Diseños laminados

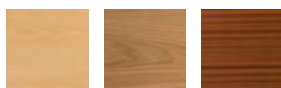

Madera natural



Blanco

RAL

NCS

Lacado blanco

Carta RAL (consultar)

Carta NCS (consultar)

Acabados armazón



Marrón

Plata

Acabados herrajes



Bronce

Cromo

Mixto

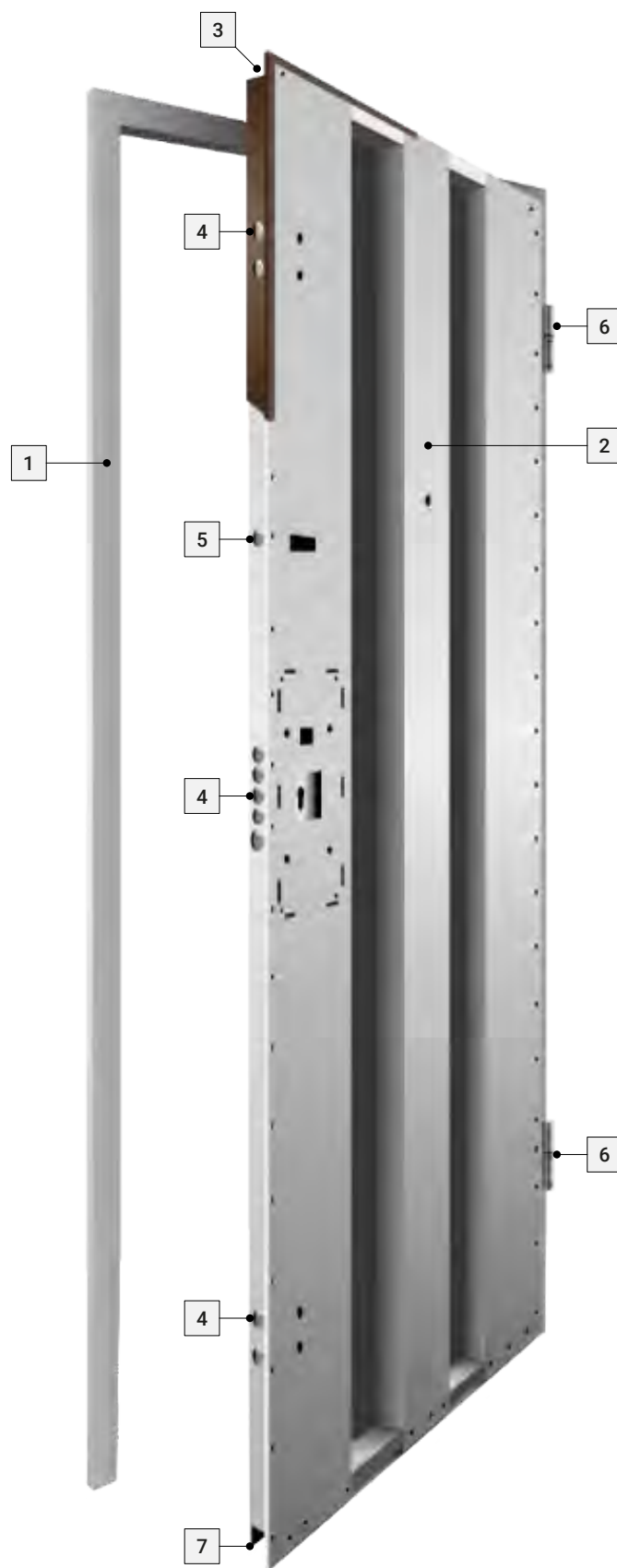

1. **MARCO:** Acero cincado 18/10, ingletes soldados y barniz en polvo de resinas de poliéster, color marrón, plata o blanco.
2. **HOJA:** Chapa de acero electrocincado 8/10 y omegas de refuerzo 8/10.
3. **CARENADO:** Perfil "Graffa" de acero pintado en marrón 8017, blanco 9003 o gris 9007.
PREMARCO: Acero cincado 18/10 con sistema de regulación y 8 garras de anclaje.
4. **CERRADURA:** Multipunto de engranajes silenciosa con 8 bulones de 40 mm.
CILINDRO: Basic llave-llave con 5 llaves y una de obra. Llave incopiable.
ESCUDO: Protección del cilindo antitaladro y antiextracción.
CERRADERO: Antitarjeta con sistema de regulación.
5. **LIMITADOR:** Sistema de apertura limitada.
6. **BISAGRAS:** Dos bisagras regulables de altura con rodamientos antidesgaste.
HERRAJE: Aluminio apto para exterior modelo NewCreta bronce/plata/latón.
JUNTAS: Doble junta en carenado y marco.
7. **CORTAVIENTO:** Umbral móvil automático inferior.
VARIANTES: Alturas especiales (consultar otras variantes).
FUNCIÓN: Entrada principal de vivienda.
SEGURIDAD: Clase 3 Antiefracción según UNE-EN 1627.
ACÚSTICA: 35dB(A) según UNE-EN 10140-2.
TÉRMICA: Transmitancia 2,2 w/m²°C en cumplimiento del CTE. Permeabilidad al aire Clase 2 según UNE-EN 1026, Anticorrosión Clase 3 y Resistencia a la carga de viento C5 según UNE-EN 1670 y UNE-EN 12211.

Puertas de entrada



Puerta blindada lacada blanca con herraje cromo

Blindada

Las puertas blindadas Di ofrecen un nivel de seguridad superior a las puertas de entrada habituales.

Su estructura reforzada con una chapa de hierro en su interior aumenta la seguridad de manera significativa y dificulta el acceso indeseado al interior. De este modo han conseguido la confianza de miles de clientes. Este tipo de puerta consigue un alto nivel de contención

frente a ataques externos con una inversión moderada por lo que son siempre una opción a tener en cuenta a la hora de buscar mecanismos de refuerzo de la seguridad en el hogar.

Las puertas blindadas Di se pueden fabricar en cualquiera de los modelos disponibles en la gama de puertas de interior, combinando distintas gamas, color de herrajes.

Estándar

Este tipo de puerta es la más utilizada en espacios interiores. Su diseño, con un grado de espesor de hoja mayor que una puerta convencional, la convierte en la opción más razonable para entornos que buscan un nivel de seguridad más elevado del habitual con un nivel de costes muy competitivo.

Acabados

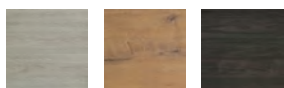

Diseños laminados

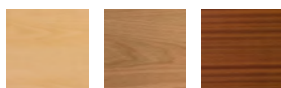

Madera natural



Blanco

Lacado blanco



RAL

Carta RAL (consultar)



NCS

Carta NCS (consultar)

Acabados herrajes



Latón

Cromo

Negro

Mixto

Herrajes



Cerradura de seguridad

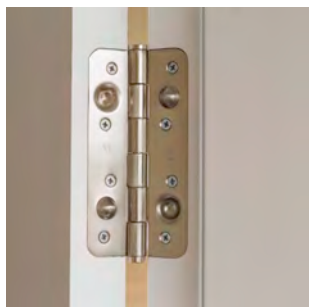

Bisagra antipalanca

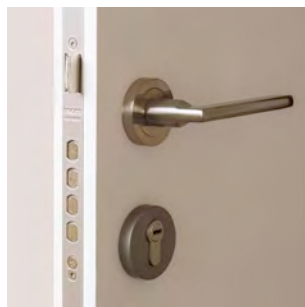

½ manilla bocallave



Visor gran angular

Tirador exterior

Bombillo antibumping

Herrajes opcionales



Bombillo antibumping



Escudo alta seguridad



Cerradura doble bombillo

Cilindro de alta seguridad anti-rotura y antibumping con barra de acero y sistema de rotura programada. El cilindro se parte ante un ataque violento. Tras la rotura el bombillo sigue siendo totalmente funcional, permitiendo al propietario abrir el cilindro con su llave.

- Cilindro de seguridad anti-rotura, con barra de acero.
- Antibumping y anti ganzúa.
- Sistema de rotura programada.
- Alta protección anti-taladro gracias a su barra interior de acero.
- Gran capacidad de amaestramiento.
- 5 llaves con doble fila de pitones.

Escudo de alta seguridad de acero que además de un bonito diseño ofrece alta resistencia a la intemperie.

- Núcleo 6 placas de acero laminado de 2 mm soldadas.
- Núcleo anti-taladro de acero F150 carbonitrurado endurecido.
- Embellecedor giratorio de acero aleado carbonitrurado y cono anti-mordaza.
- Doble contraplaca interior 4+4 mm de espesor.

- Cerradura de seguridad de 4 puntos. Uno de ellos con cilindro independiente.
- Alta resistencia al apalancamiento.
- Frente de aluminio de 22 mm de ancho y 2030 mm de longitud.
- Cilindros amaestrados, uno de ellos con botón. Puerta de Servicio. Refuerzo cerradero en dotación.
- Picaporte y bulones niquelados. Caja cerrada de acero. Picaporte reversible y accionable mediante manilla o llave.

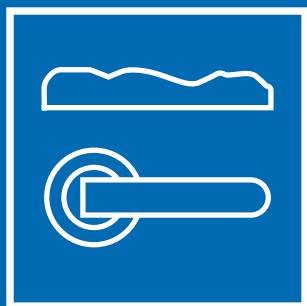

Molduras y accesorios

Conseguir espacios armónicos es una tarea más sencilla de lo que parece.

Las molduras y sus numerosas variantes encajan impecablemente con el diseño de las puertas consiguiendo un efecto de continuidad e integración.

Además, nuestro amplio abanico de accesorios asegura el toque final perfecto para hacer de cualquier proyecto una realidad.

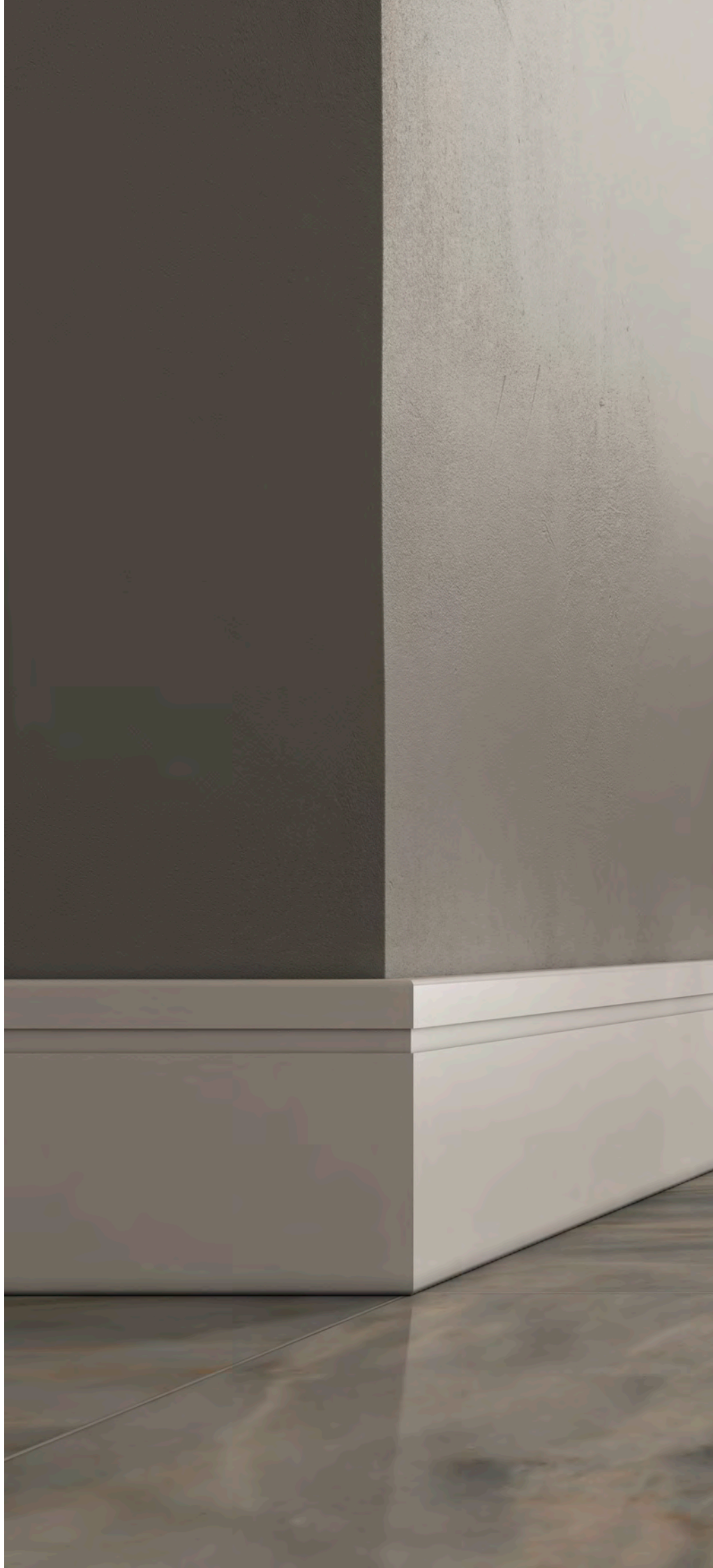



Molduras y accesorios

Batientes

De igual diseño que la puerta en Dimoldura fabricamos batientes de alta resistencia a impactos y reducida rumorosidad. Desde modelos más sencillos hasta batientes con diferentes soluciones de extensión, la variedad es una de nuestras señas de identidad.

Soportes



MDF



MDF hidrófugo



Contrachapado



Pino alistonado /
Finger

Acabados

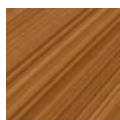

Chapa madera



Papel diseño

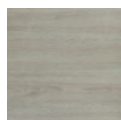

Laminadas



Blanco

Lacado blanco



Directo

Lacado directo

Opciones batientes



Extensible 1 lado



Extensible 2 lados



Universal



Universal extensible



Cerco mixto extensible 1 lado



Cerco mixto universal

Tapetas

Disponibles en los mismos acabados que las puertas son un complemento imprescindible. Por eso en Dimoldura disponemos de todas las combinaciones para garantizar una integración perfecta.

Soportes



MDF



MDF hidrófugo



Contrachapado

Acabados



Chapa madera



Papel diseño

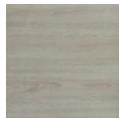

Laminadas



Lacado blanco



Lacado directo

Opciones tapetas



Tapeta



Tapeta acanalada



Tapeta extensible 25mm



Tapeta extensible 45mm *



Tapeta aireadora



Tapeta aireadora extensible



Tapeta moldurada 344 **



Tapeta moldurada 345*



Tapeta moldurada 346 **



Tapeta moldurada 430 *



Tapeta moldurada 431 **



Cantonera



Listón vidriera

* Disponible solo en blanco
** Disponible solo en chapa

Molduras y accesorios



Rodapié

Una buena elección confiere a cualquier espacio un aspecto refinado y elegante.



Estándar

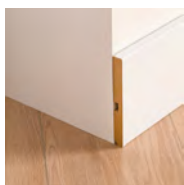

Pasacables



Cubrezócalo



Doble labio



Diseño Liso



Diseño 710

Soportes



MDF



MDF hidrófugo



Aglomerado



Contrachapado



Pino alistonado /
Finger

Acabados

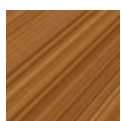

Chapa madera



Papel diseño

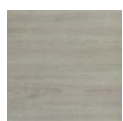

Laminado



Blanco

Lacado blanco



Directo

Lacado directo

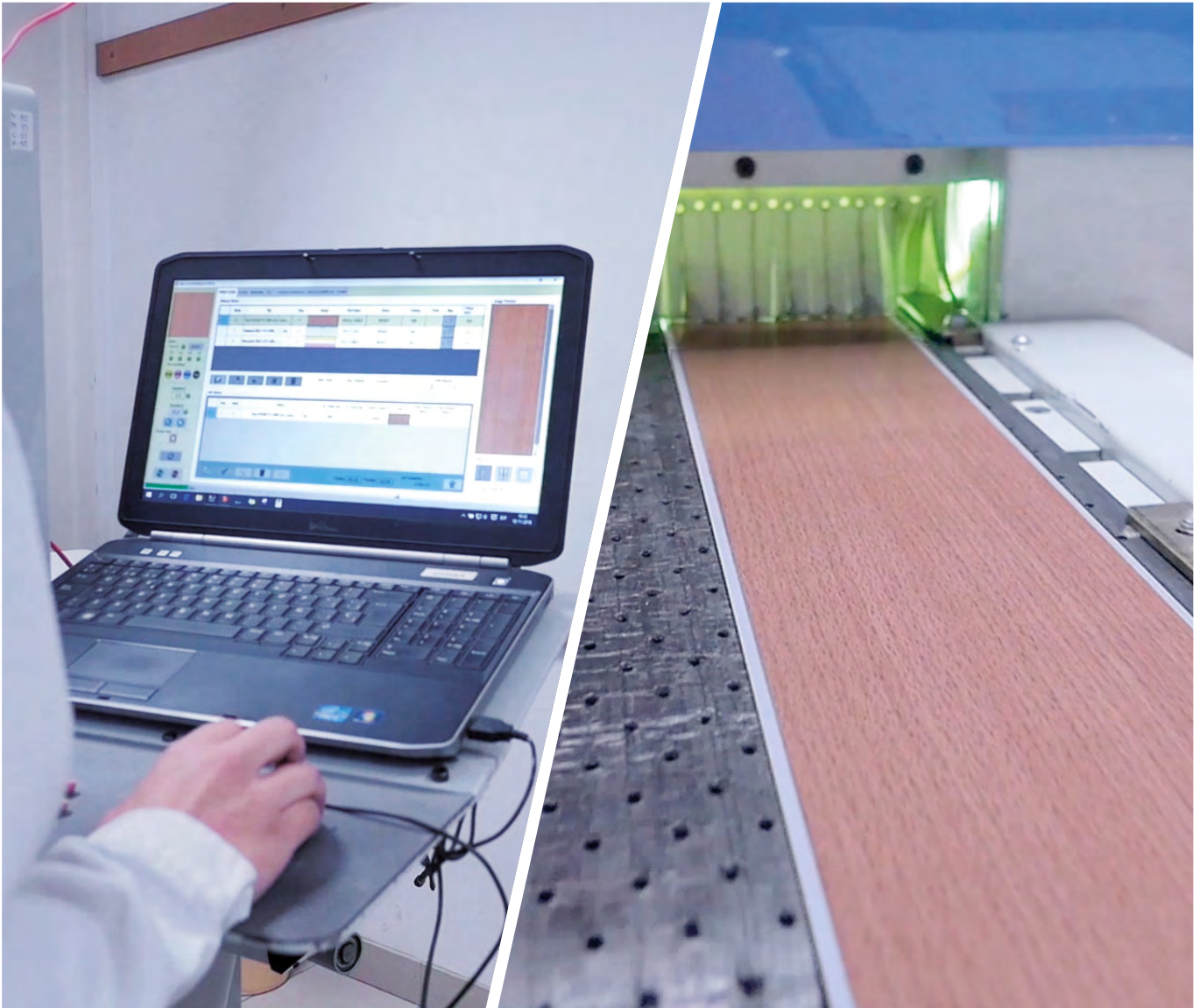
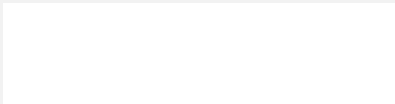

Diseños personalizables a medida para cada cliente

Más de 300 diseños personalizados avalan la experiencia de Dimoldura en crear molduras únicas con impresión digital.

Crear un diseño personalizado mediante impresión digital, a medida, es posible.

Dimoldura cuenta con la tecnología necesaria para diseñar y fabricar molduras a medida. Colores, patrones o diseños exclusivos, la personalización es posible gracias a la capacidad de Di de contratar cualquier rodapié, batiente o tapeta ideado por la

imaginación del cliente. Esta posibilidad abre una puerta a infinitas combinaciones creativas, tantas como el cliente sea capaz de crear. Mediante un software de personalización damos forma al diseño facilitado para posteriormente trasladarlo a producción y obtener como resultado final un producto único y diferenciado, perfecto para conseguir ambientes singulares y con personalidad.



Molduras y accesorios



Kit Corredera

Las puertas correderas son la respuesta perfecta para aprovechar el espacio disponible al máximo. Los kits de instalación Dimoldura combinan fiabilidad, facilidad de uso y diseño para crear un espacio ideal en cada estancia.

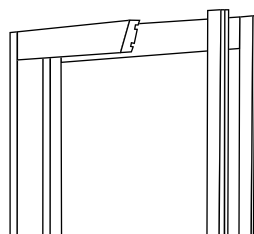

Kit corredera interior

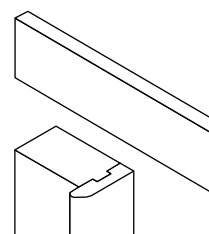

Kit corredera exterior

Soportes interior y exterior



MDF



MDF hidrófugo

Acabados

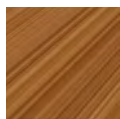

Chapa



Papel diseño

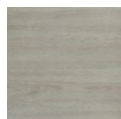

Laminadas



Blanco

Lacado blanco

Accesorios

Uñeros, manillas o cantoneras, en Dimoldura ponemos a su disposición un sinfín de posibilidades siguiendo las nuevas tendencias en decoración e interiorismo.

Modernos y vanguardistas o espacios más clásicos y atemporales, cualquier elección tiene los accesorios adecuados.

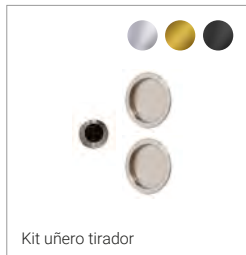

Kit uñero tirador



Uñero pico loro



Uñero bombillo



Bisagra pala



Bisagra antipalanca



Bisagra oculta



Pernio



Picaporte unificado



Picaporte magnético estándar



Picaporte magnético premium



Picaporte llave Borja



Cerradura de bombillo para puerta de paso



Cerradura 3 puntos doble bombillo



Cerradura 3 puntos

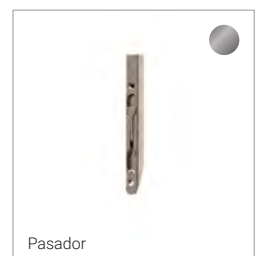

Pasador



Bombillo



Manilla



Pomo

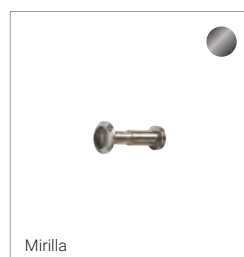

Mirilla



Ojo de buey



Cierrpuertas



Guillotina

Acabados

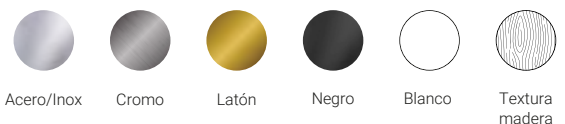

Guía rápida

Modelos – Lacadas

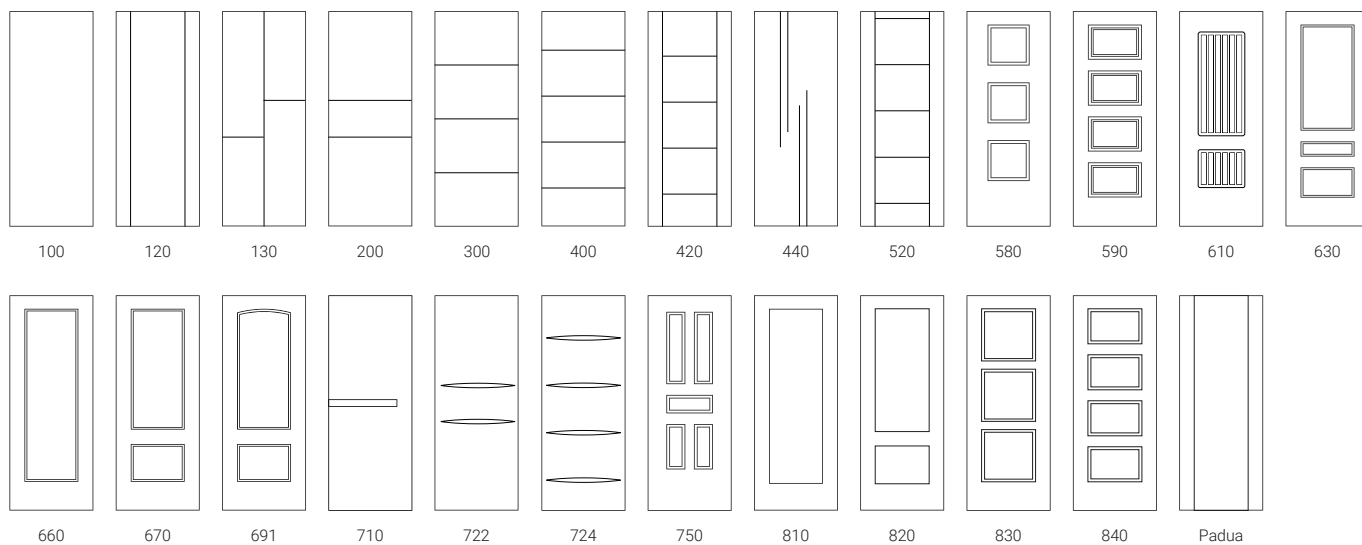

Vidrieras – Lacadas / Laminadas / Madera / Impress

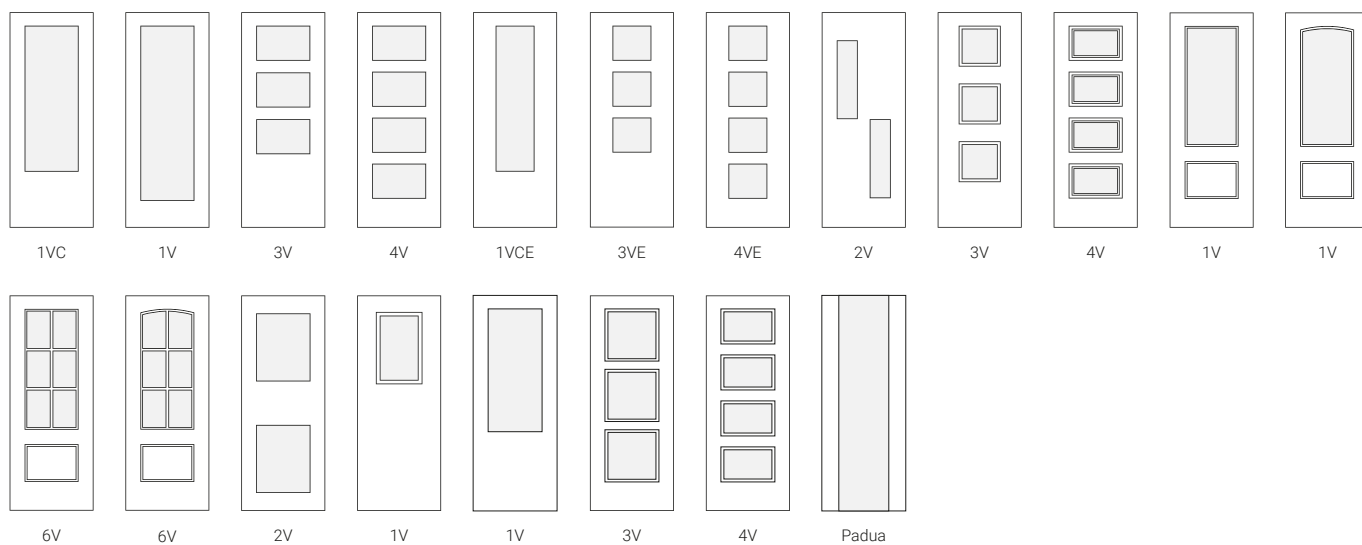

Vetas

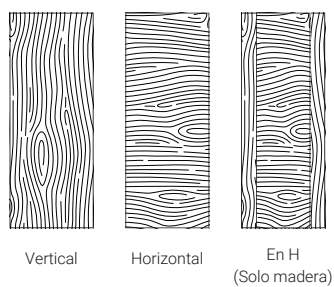

Fresados – Laminadas

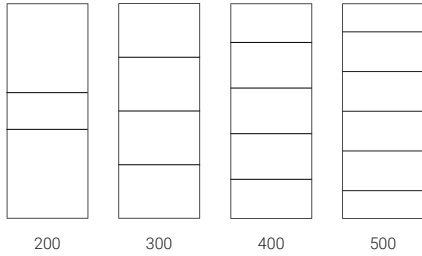

200 300 400 500

Fresados – Madera

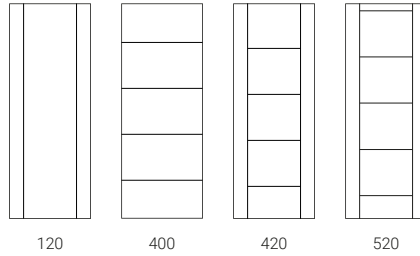

120 400 420 520

Tipos de ranuras e inserciones

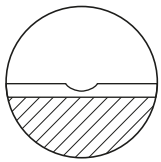

Media caña
(Lacadas)

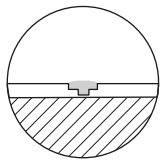

Inserción metálica
(Lacadas / Laminadas /
Madera)

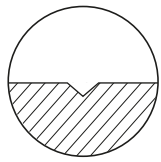

Viva pintada
negra o marrón
(Laminadas)

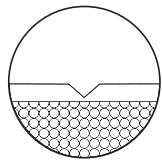

Viva sobre MDF
barnizada (Laminadas)

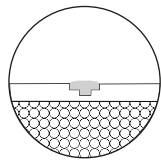

Inserción metálica
(Laminadas)

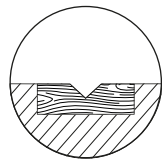

Viva sobre madera
barnizada (Madera)

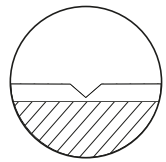

Viva sobre MDF
barnizada (Madera)

Tapetas y molduras

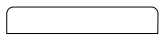

Tapeta plana

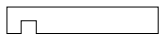

Tapeta acanalada

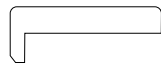

Tapeta extensible 25mm

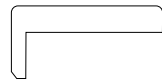

Tapeta extensible 35mm

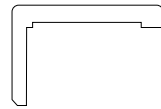

Tapeta extensible 45mm



Tapeta aireadora

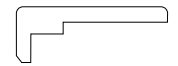

Tapeta aireadora
extensible



344



345



346



430



431

Tipos

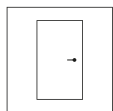

Interior

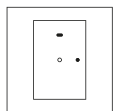

Entrada

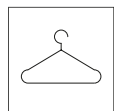

Armario

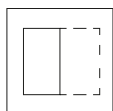

Fija

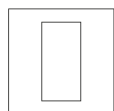

Tablero

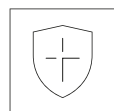

Blindada

Formatos

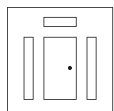

Kit

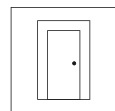

Block

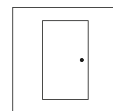

Hoja

Versiones

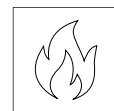



Resistente
al fuego







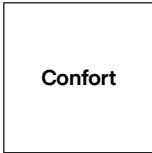
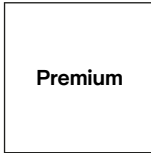

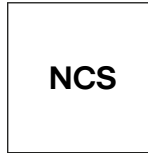
Protect +

Guía rápida

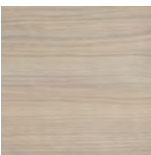
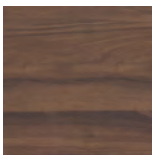

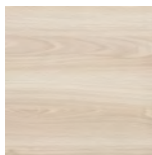
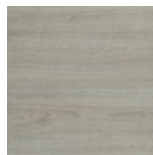

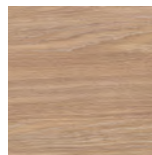
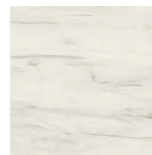
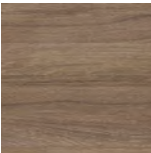
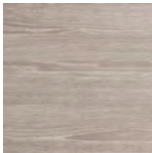
Acabados – Lacadas

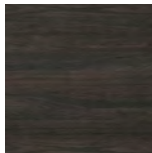
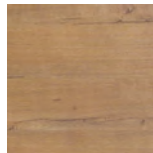
 <p>Pre-lacado</p>	 <p>Confort</p>	 <p>Premium</p>	 <p>Anti-bacteriano</p>	 <p>RAL</p>	 <p>NCS</p>
Blanco Pre-lacado	Blanco Lacado Confort	Blanco Lacado Premium	Antibacteriano	Carta RAL (consultar)	Carta NCS (consultar)

Acabados – Laminadas

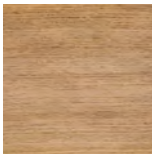
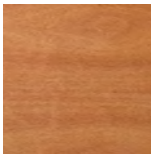
							
Gris Angora	Nogal Estocolmo	Roble Nature	Nogal Arena	Vila Gris	Fresno Eslovenia	Roble Urban	Roble Ártico
							
Roble Coffee	Roble Finandés	Roble Nórdico	Carbón Texture	Roble Gold			

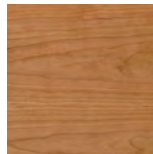
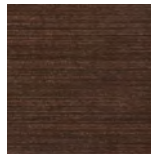
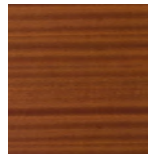
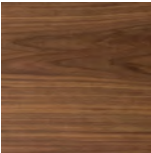
Acabados – Madera

						
Roble Americano	Roble Europeo	Cedro	Haya Vaporizada	Cerezo	Wengué	Sapelly
						
Nogal	Pino Melis					

Acabados – Impress

					
Blanco Wass	Alba Clarium	Roble Oxford	Quercus Rubra	Sapelly	Haya vaporizada

Acabados armazón – Acorazadas



Marrón

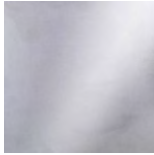

Plata

Acabados herrajes – Acorazadas

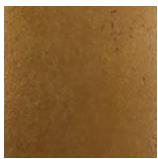

Bronce



Cromo

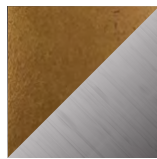

Mixto
Bronce/Cromo

Acabados herrajes – Blindada / Estándar



Latón



Cromo



Negro



Mixto
Latón/Cromo



Mixto
Cromo/Negro

Acabados – Accesorios

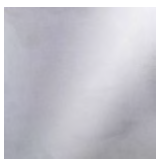

Acero/Inox

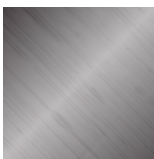

Cromo



Latón

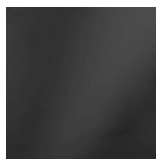

Negro



Blanco

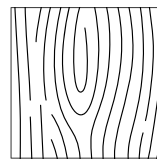

Textura madera